

PROJECT
TYPE
SPECIFIER
QUANTITY
DATE

## IDAHO 40 TRIMLESS

### A35664-

base number	LED Dimming	Color Temperature	Ceiling Thickness
-------------	-------------	-------------------	-------------------

- To build a product code in our configurator select the specify button on the base model # product page
- To build a manual product code on this datasheet choose from the options listed below in blue font and add the suffix to the base model #

#### GENERAL

Series: Idaho
Subseries: Idaho 40
Brand: Prolicht
Division: Architectural
Mounting Type: Trimless
Mounting Location: Ceiling
Subcategory: Profile

#### PHYSICAL

Shape: Rectangle
Length (mm): 880
Length (in): 34 5/8
Width (mm): 42
Width (in): 1 5/8
Height (mm): 97
Height (in): 3 13/16
Ceiling Thickness (mm): 10 / 12.5 / 15
Ceiling Thickness (in): 3/8 or 1/2 or 9/16
Min. Recessing Depth (mm): 135
Min. Recessing Depth (in): 5 5/16
Light Distribution: Direct
Weight (kg): 2.477
Weight (lbs): 5.48
Diffuser: PMMA - Opal
Fixture Material: Aluminum
Cut-out Measurements: 888mm / 34 15/16" x 55mm / 2 3/16"
Upon Request: Unique Sizes Unique Ceiling Thickness

#### ELECTRICAL

Lamp Type: LED (Zhaga Standard)
Input Wattage (W): 14
Total Output Wattage (W): 12
Dimming: Non-Dimming / Phase Dimming (120Vac only) / 0-10V Dimming
Driver Included: Yes
Driver Location: Integrated
Driver Type: Constant Current - 120 / 277Vac
Driver Class: Class 2
Input Voltage (V): 120 - 277
Constant Current (MA): 350

#### LED

Color Temperature (°K): 3000 / 3500 / 4000
Max. Delivered Lumen (lm): 730 / 755 / 770
CRI: >80 CRI
Lamp Life (hrs): 50000
Upon Request: Special Color Temperature RGB-W Tunable White CRI (no minimum qty) price increase + longer lead time

#### OPTICAL

#### RATINGS AND CERTIFICATIONS

Certified By: Certified for North American Standards
IP rating: IP20

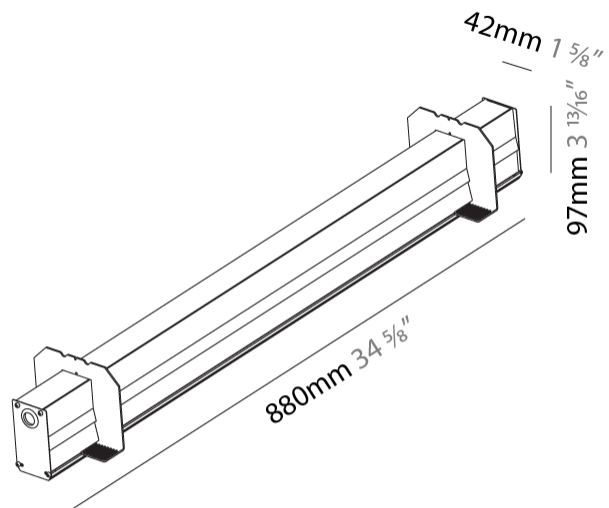
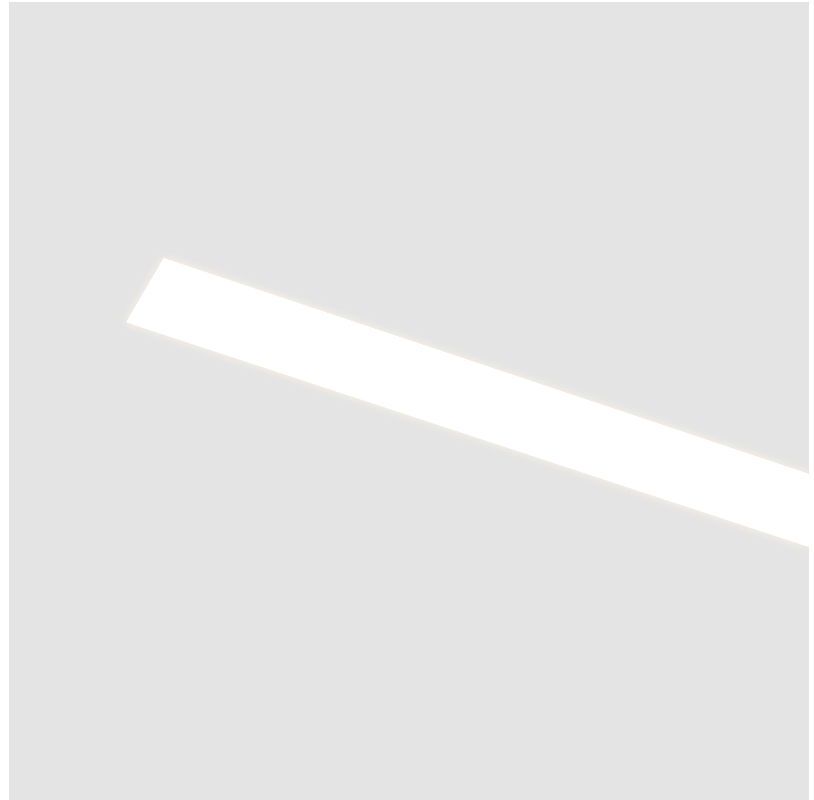

PROJECT	_____
TYPE	_____
SPECIFIER	_____
QUANTITY	_____
DATE	_____

For Color / Finish Chart & Symbology see Appendix or product page downloadable area.

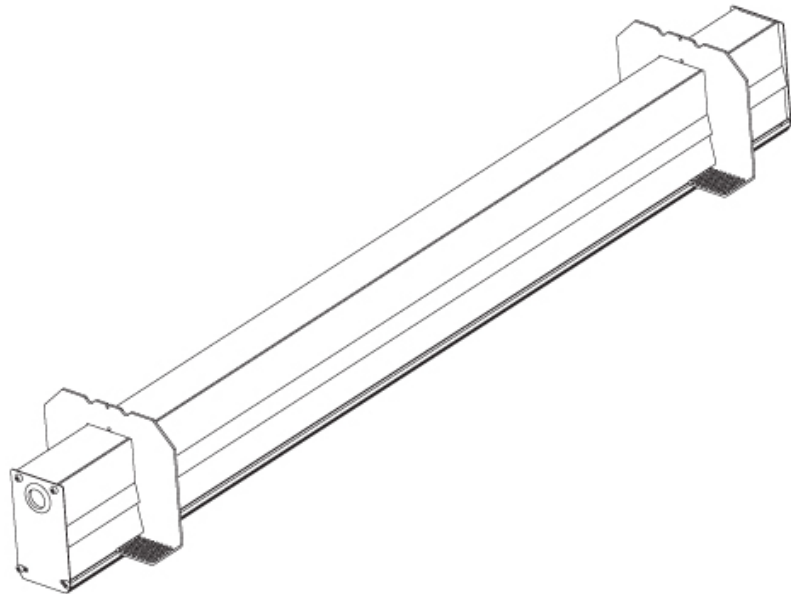

	DP	DV	
Dimming	Phase	0-10V	
Color Temperature	30K 3000K	35K 3500K	40K 4000K
Ceiling Thickness	10 10	12 12.5	15 15

ORDER-EXAMPLE: °K ↑  
**L3XXXX-** DV 30K 10  
 0-10V 3000K 10



PROJECT	_____
TYPE	_____
SPECIFIER	_____
QUANTITY	_____
DATE	_____

## IDAHO 40 TRIMLESS

### A35665-

base number	LED	Color	Ceiling
	Dimming	Temperature	Thickness

- To build a product code in our configurator select the specify button on the base model # product page
- To build a manual product code on this datasheet choose from the options listed below in blue font and add the suffix to the base model #

#### GENERAL

Series: Idaho
Subseries: Idaho 40
Brand: Prolicht
Division: Architectural
Mounting Type: Trimless
Mounting Location: Ceiling
Subcategory: Profile

#### PHYSICAL

Shape: Rectangle
Length (mm): 1160
Length (in): 45 <sup>11</sup> / <sub>16</sub>
Width (mm): 42
Width (in): 1 <sup>5</sup> / <sub>8</sub>
Height (mm): 97
Height (in): 3 <sup>13</sup> / <sub>16</sub>
Ceiling Thickness (mm): 10 / 12.5 / 15
Ceiling Thickness (in): 3/8 or 1/2 or 9/16
Min. Recessing Depth (mm): 135
Min. Recessing Depth (in): 5 <sup>5</sup> / <sub>16</sub>
Light Distribution: Direct
Weight (kg): 3.244
Weight (lbs): 7.14
Diffuser: PMMA - Opal
Fixture Material: Aluminum
Cut-out Measurements: 1168mm / 46" x 55mm / 2 3/16"
Upon Request: Unique Sizes Unique Ceiling Thickness

#### ELECTRICAL

Lamp Type: LED (Zhaga Standard)
Input Wattage (W): 17.5
Total Output Wattage (W): 15
Dimming: Non-Dimming / Phase Dimming (120Vac only) / 0-10V Dimming
Driver Included: Yes
Driver Location: Integrated
Driver Type: Constant Current - 120 / 277Vac
Driver Class: Class 2
Input Voltage (V): 120 - 277
Constant Current (MA): 350

#### LED

Color Temperature (°K): 3000 / 3500 / 4000
Max. Delivered Lumen (lm): 970 / 1009 / 1030
CRI: >80 CRI
Lamp Life (hrs): 50000
Upon Request: Special Color Temperature RGB-W Tunable White CRI (no minimum qty) price increase + longer lead time

#### OPTICAL

#### RATINGS AND CERTIFICATIONS

Certified By: Certified for North American Standards
IP rating: IP20

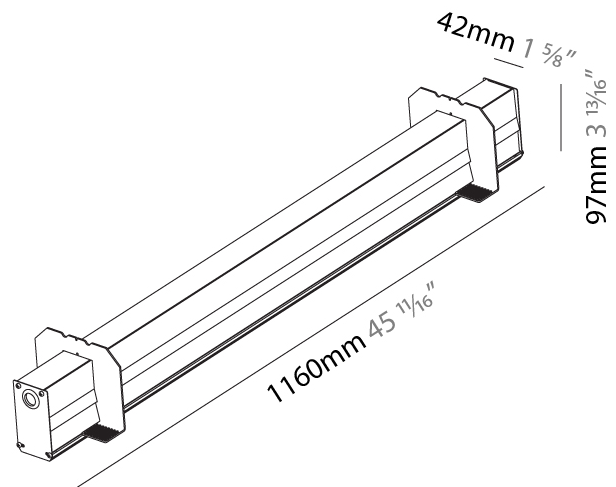

PROJECT	_____
TYPE	_____
SPECIFIER	_____
QUANTITY	_____
DATE	_____

For Color / Finish Chart & Symbology see Appendix or product page downloadable area.

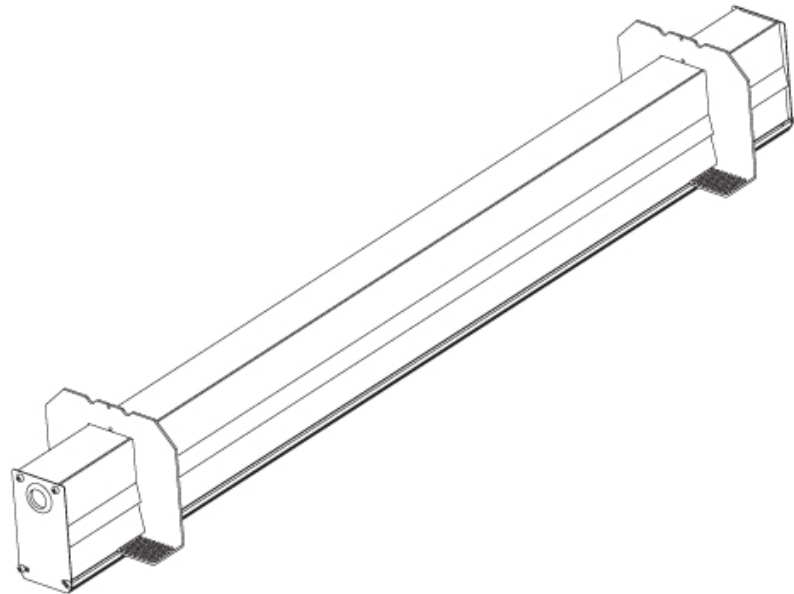

	DP	DV	
Dimming	Phase	0-10V	
Color Temperature	30K	35K	°K
	3000K	3500K	
Ceiling Thickness	10	12	↑
	10	12.5	

ORDER-EXAMPLE: °K ↑  
**L3XXXX-** DV 30K 10  
 0-10V 3000K 10



PROJECT	_____
TYPE	_____
SPECIFIER	_____
QUANTITY	_____
DATE	_____

## IDAHO 40 TRIMLESS

### A35666-

base number	LED	Color	Ceiling
	Dimming	Temperature	Thickness

- To build a product code in our configurator select the specify button on the base model # product page
- To build a manual product code on this datasheet choose from the options listed below in blue font and add the suffix to the base model #

#### GENERAL

Series: Idaho
Subseries: Idaho 40
Brand: Prolicht
Division: Architectural
Mounting Type: Trimless
Mounting Location: Ceiling
Subcategory: Profile

#### PHYSICAL

Shape: Rectangle
Length (mm): 1440
Length (in): 56 <sup>11</sup> / <sub>16</sub>
Width (mm): 42
Width (in): 1 <sup>5</sup> / <sub>8</sub>
Height (mm): 97
Height (in): 3 <sup>13</sup> / <sub>16</sub>
Ceiling Thickness (mm): 10 / 12.5 / 15
Ceiling Thickness (in): 3/8 or 1/2 or 9/16
Min. Recessing Depth (mm): 135
Min. Recessing Depth (in): 5 <sup>5</sup> / <sub>16</sub>
Light Distribution: Direct
Weight (kg): 3.866
Weight (lbs): 8.51
Diffuser: PMMA - Opal
Fixture Material: Aluminum
Cut-out Measurements: 1448mm / 57" x 55mm / 2 3/16"
Upon Request: Unique Sizes Unique Ceiling Thickness

#### ELECTRICAL

Lamp Type: LED (Zhaga Standard)
Input Wattage (W): 21
Total Output Wattage (W): 18
Dimming: Non-Dimming / Phase Dimming (120Vac only) / 0-10V Dimming
Driver Included: Yes
Driver Location: Integrated
Driver Type: Constant Current - 120 / 277Vac
Driver Class: Class 2
Input Voltage (V): 120 - 277
Constant Current (MA): 350

#### LED

Color Temperature (°K): 3000 / 3500 / 4000
Max. Delivered Lumen (lm): 1210 / 1254 / 1280
CRI: >80 CRI
Lamp Life (hrs): 50000
Upon Request: Special Color Temperature RGB-W Tunable White CRI (no minimum qty) price increase + longer lead time

#### OPTICAL

#### RATINGS AND CERTIFICATIONS

Certified By: Certified for North American Standards
IP rating: IP20

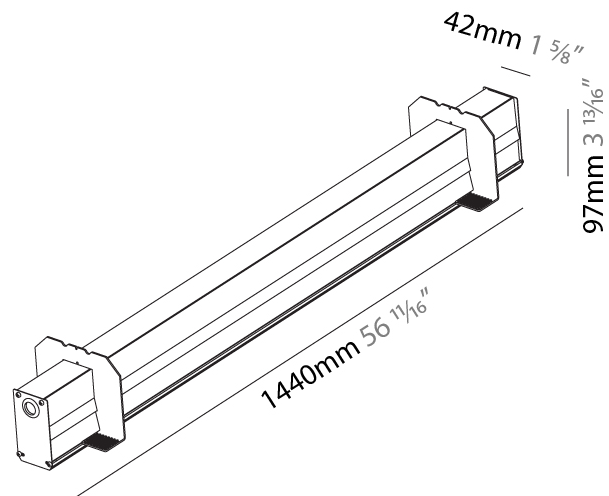
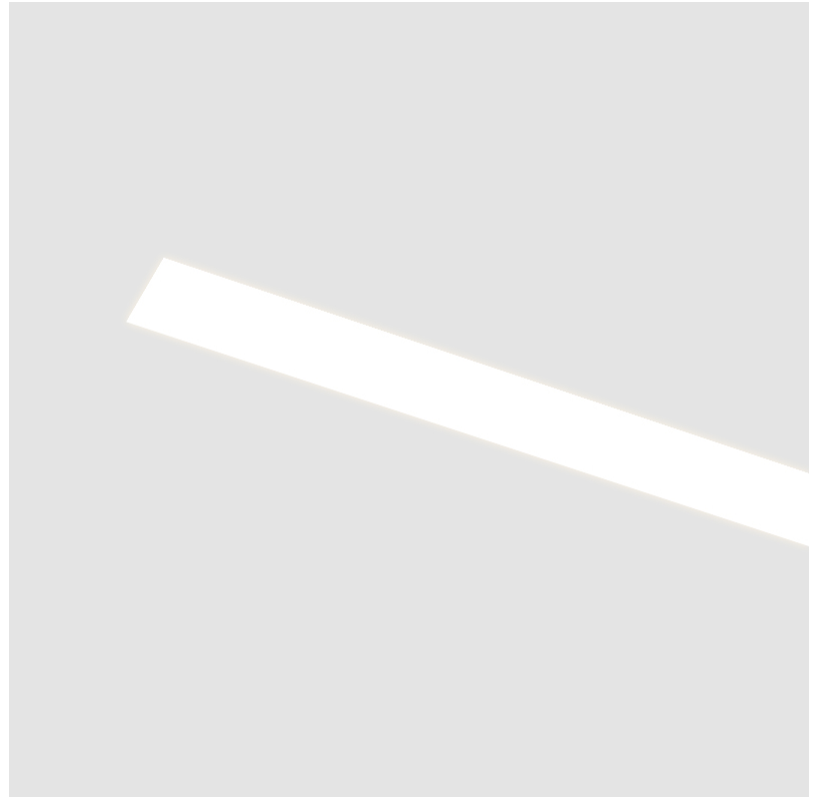

PROJECT	_____
TYPE	_____
SPECIFIER	_____
QUANTITY	_____
DATE	_____

For Color / Finish Chart & Symbology see Appendix or product page downloadable area.

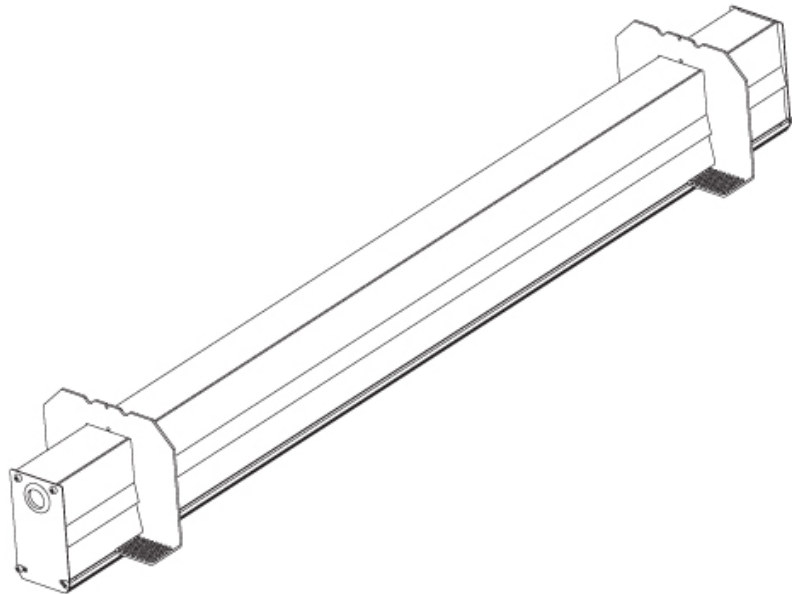

	DP	DV	
Dimming	Phase	0-10V	
Color Temperature	30K	35K	40K
	3000K	3500K	4000K
Ceiling Thickness	10	12	15
	10	12.5	15

ORDER-EXAMPLE: °K ↑  
**L3XXXX-** DV 30K 10  
 0-10V 3000K 10



PROJECT	_____
TYPE	_____
SPECIFIER	_____
QUANTITY	_____
DATE	_____

## IDAHO 40 TRIMLESS

### A35667-

base number	LED	Color	Ceiling
	Dimming	Temperature	Thickness

- To build a product code in our configurator select the specify button on the base model # product page
- To build a manual product code on this datasheet choose from the options listed below in blue font and add the suffix to the base model #

#### GENERAL

Series: Idaho
Subseries: Idaho 40
Brand: Prolicht
Division: Architectural
Mounting Type: Trimless
Mounting Location: Ceiling
Subcategory: Profile

#### PHYSICAL

Shape: Rectangle
Length (mm): 1720
Length (in): 67 <sup>11</sup> / <sub>16</sub>
Width (mm): 42
Width (in): 1 <sup>5</sup> / <sub>8</sub>
Height (mm): 97
Height (in): 3 <sup>13</sup> / <sub>16</sub>
Ceiling Thickness (mm): 10 / 12.5 / 15
Ceiling Thickness (in): 3/8 or 1/2 or 9/16
Min. Recessing Depth (mm): 135
Min. Recessing Depth (in): 5 <sup>5</sup> / <sub>16</sub>
Light Distribution: Direct
Weight (kg): 4.662
Weight (lbs): 10.26
Diffuser: PMMA - Opal
Fixture Material: Aluminum
Cut-out Measurements: 1728mm / 68 1/16" x 55mm / 2 3/16"
Upon Request: Unique Sizes Unique Ceiling Thickness

#### ELECTRICAL

Lamp Type: LED (Zhaga Standard)
Input Wattage (W): 24.5
Total Output Wattage (W): 21
Dimming: Non-Dimming / Phase Dimming (120Vac only) / 0-10V Dimming
Driver Included: Yes
Driver Location: Integrated
Driver Type: Constant Current - 120 / 277Vac
Driver Class: Class 2
Input Voltage (V): 120 - 277
Constant Current (MA): 350

#### LED

Color Temperature (°K): 3000 / 3500 / 4000
Max. Delivered Lumen (lm): 1460 / 1509 / 1540
CRI: >80 CRI
Lamp Life (hrs): 50000
Upon Request: Special Color Temperature RGB-W Tunable White CRI (no minimum qty) price increase + longer lead time

#### OPTICAL

#### RATINGS AND CERTIFICATIONS

Certified By: Certified for North American Standards
IP rating: IP20

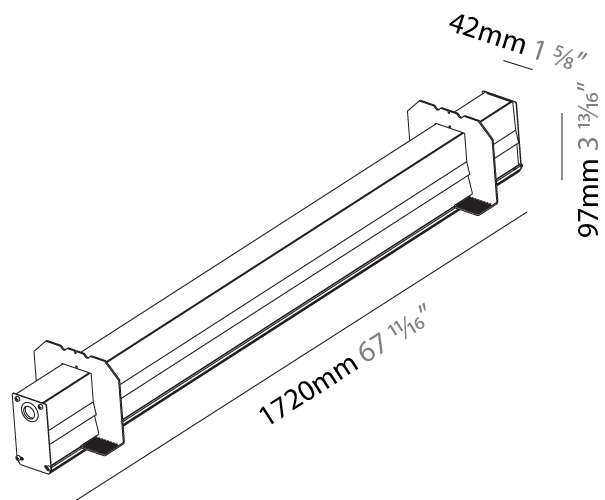
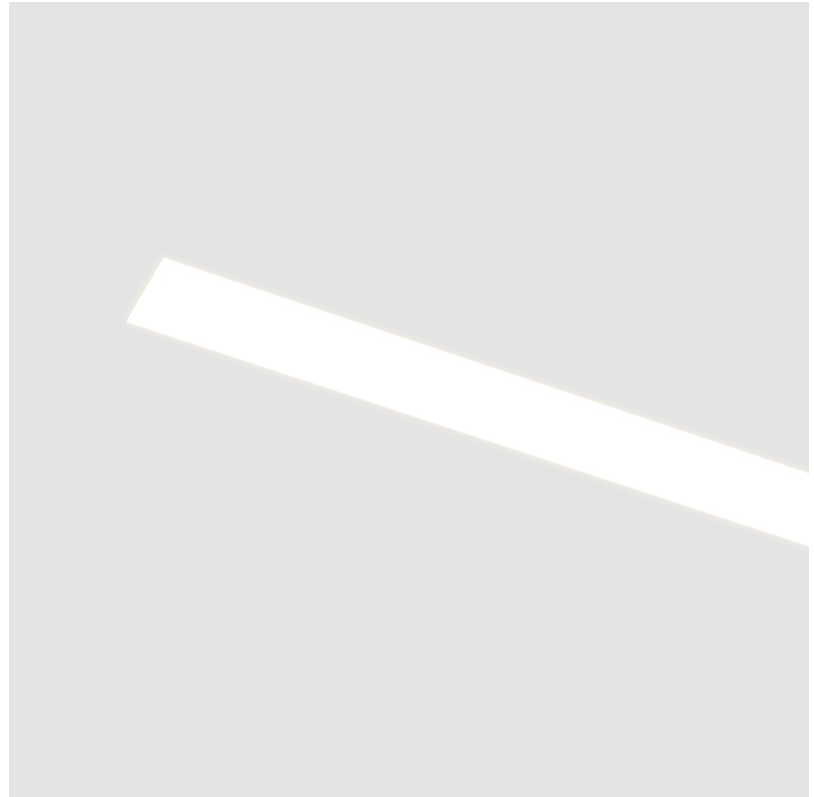

PROJECT	_____
TYPE	_____
SPECIFIER	_____
QUANTITY	_____
DATE	_____

For Color / Finish Chart & Symbology see Appendix or product page downloadable area.

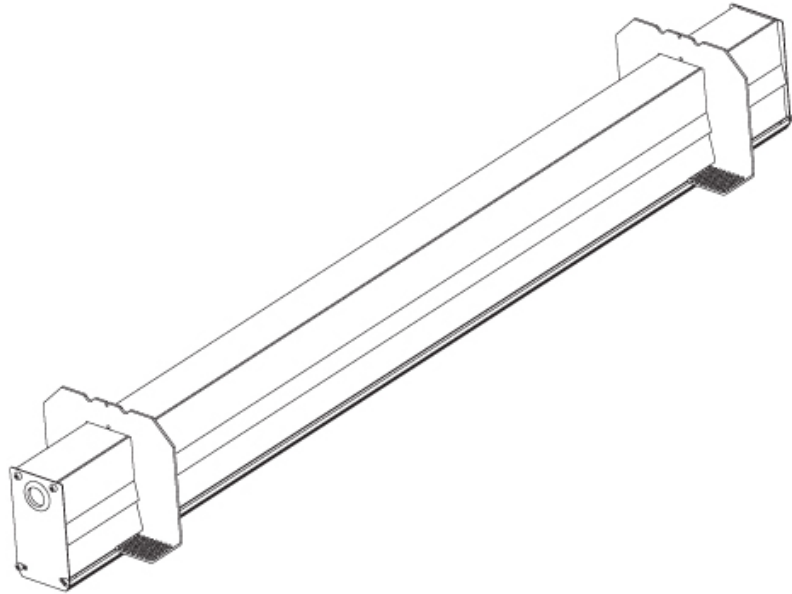

	DP	DV	
Dimming	Phase	0-10V	
Color Temperature	30K	35K	40K
	3000K	3500K	4000K
Ceiling Thickness	10	12	15
	10	12.5	15

ORDER-EXAMPLE: °K ↑  
**L3XXXX-** DV 30K 10  
 0-10V 3000K 10





PROJECT
TYPE
SPECIFIER
QUANTITY
DATE

## IDAHO 40 TRIMLESS

### A35668-

base number	LED Dimming	Color Temperature	Ceiling Thickness
-------------	-------------	-------------------	-------------------

- To build a product code in our configurator select the specify button on the base model # product page
- To build a manual product code on this datasheet choose from the options listed below in blue font and add the suffix to the base model #

#### GENERAL

Series: Idaho
Subseries: Idaho 40
Brand: Prolicht
Division: Architectural
Mounting Type: Trimless
Mounting Location: Ceiling
Subcategory: Profile

#### PHYSICAL

Shape: Rectangle
Length (mm): 2000
Length (in): 78 3/4
Width (mm): 42
Width (in): 1 5/8
Height (mm): 97
Height (in): 3 13/16
Ceiling Thickness (mm): 10 / 12.5 / 15
Ceiling Thickness (in): 3/8 or 1/2 or 9/16
Min. Recessing Depth (mm): 135
Min. Recessing Depth (in): 5 5/16
Light Distribution: Direct
Weight (kg): 5.284
Weight (lbs): 11.62
Diffuser: PMMA - Opal
Fixture Material: Aluminum
Cut-out Measurements: 2008mm / 79 1/16" x 55mm / 2 3/16"
Upon Request: Unique Sizes Unique Ceiling Thickness

#### ELECTRICAL

Lamp Type: LED (Zhaga Standard)
Input Wattage (W): 28
Total Output Wattage (W): 24
Dimming: Non-Dimming / Phase Dimming (120Vac only) / 0-10V Dimming
Driver Included: Yes
Driver Location: Integrated
Driver Type: Constant Current - 120 / 277Vac
Driver Class: Class 2
Input Voltage (V): 120 - 277
Constant Current (MA): 350

#### LED

Color Temperature (°K): 3000 / 3500 / 4000
Max. Delivered Lumen (lm): 1700 / 1764 / 1800
CRI: >80 CRI
Lamp Life (hrs): 50000
Upon Request: Special Color Temperature RGB-W Tunable White CRI (no minimum qty) price increase + longer lead time

#### OPTICAL

#### RATINGS AND CERTIFICATIONS

Certified By: Certified for North American Standards
IP rating: IP20

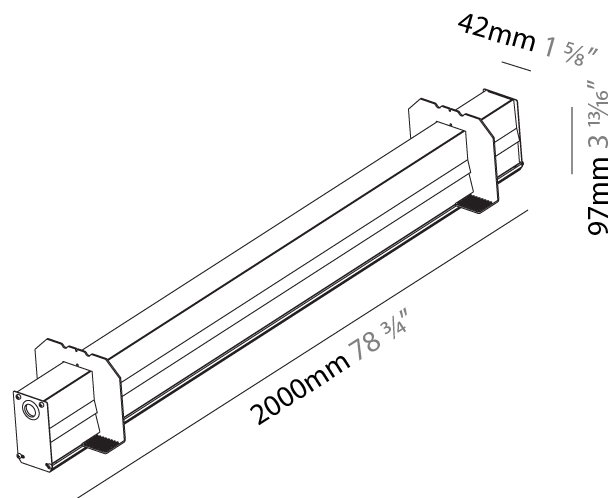
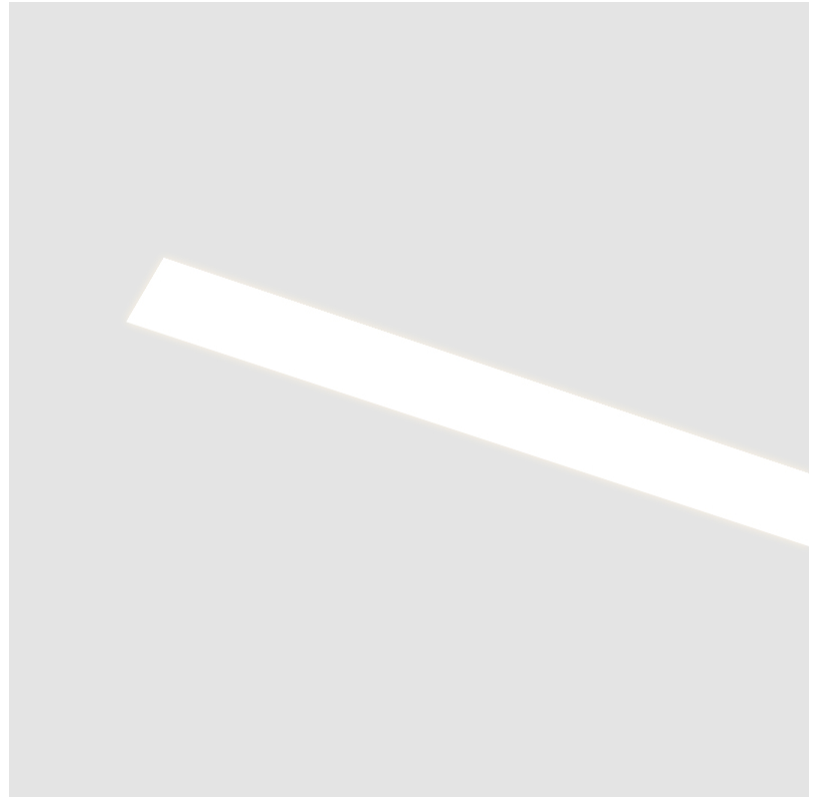

PROJECT	_____
TYPE	_____
SPECIFIER	_____
QUANTITY	_____
DATE	_____

For Color / Finish Chart & Symbology see Appendix or product page downloadable area.

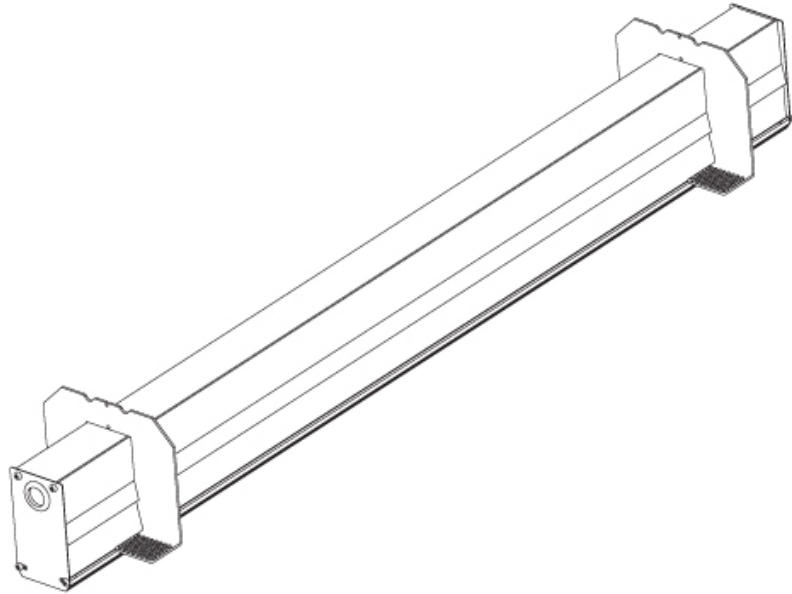

	DP	DV	
Dimming	Phase	0-10V	
Color Temperature	30K 3000K	35K 3500K	40K 4000K
Ceiling Thickness	10 10	12 12.5	15 15

ORDER-EXAMPLE: °K   
**L3XXXX-** DV 30K 10  
 0-10V 3000K 10



PROJECT

TYPE

SPECIFIER

QUANTITY

DATE

### Fixture Finish

**Digital:** Not all screens are calibrated the same, and therefore, colors will appear differently between screens.





































































**Physical:** When texture is involved, there will be variations in color, character and tone within a product series and between product families.

**Gun Metal:** No Gun Metal finish is alike. It combines a mixture of transparent and black color particles which ensures a highly individual effect and no luminaire being identical.

**Champagne Cream, Copper Mine, Ancient Bronze + Jazz Gold:** These finishes have slight fading from specific powder coating production. Each luminaire will slightly vary.



### LEGEND

	floor-mounted		pivotal		special LED (upon request) RGB, RGBW, tunable, gold+, meat+, art+, fashion+
	wall and ceiling: recessed and surface mounted		rotating		warm dim / natural dimming LED
	ceiling-mounted and wall-mounted		illuminate tilted		rechargeable battery powered
	wall-mounted		color of suspension cable		fixture with natural vivid LED (upon request)
	omni-directional light distribution		length of suspension cable		color rendering index
	direct light distribution		reflector degree selection		color temperature
	direct/indirect light distribution		super spot		lumen (luminous flux)
	indirect light distribution		lens		efficacy (lumens per watt)
	asymmetric light distribution		lens pack		Unified Glare Rating (UGR) range from 5-40
	aura light distribution		shine ring		marine grade (AISI 316 stainless steel)
	round wall or ceiling cut-out		integrated shine ring with diffuser		walk on
	square wall or ceiling cut-out		free individual colors 01-29		drive on
	the supplied jig specifies the cutout dimensions		individual colors: 00 (free of charge), 01-25 (extra charge)		Dark Sky Compliance
	minimum distance (meters) lamp - object		luminaire part to be colored (F1)		Americans with Disabilities Act (less than 4" off the wall located between 27"-84" from floor)
	recessed depth		luminaire part to be colored (F2)		lamp protected against explosion
	ceiling thickness in mm		luminaire part to be colored (F3)		blown glass using traditional methods by master glass blower
	ceiling thickness selection		luminaire part to be colored (F4)		acoustic material
	dimmable DP (phase), DV (0-10V), DD (dali), DS (step-dim)		luminaire part to be colored (F5)		protection class I, protection insulation
	included or excluded LED driver/transformer/control gear		color of 3-circuit adaptor		protection class II, protection insulation
	separately switchable		indirect diffuser		ETL Certified to UL and CSA Standards
	sensor		direct diffuser		UL Certified to UL and CSA Standards
	remote control		ball-proof (upon request)		CSA Certified to UL and CSA Standards
	available upon request		accessory		Certified for North American Standards

### IP RATING

	protected against ingress of solid bodies greater than 12.5mm (finger)
	protected against ingress of solid bodies greater than 2.5mm protected against sprays of water up to 60 degrees from the vertical (rain)
	protected against ingress of solid bodies greater than 1mm (wire) no protection against the ingress of moisture
	protected against ingress of solid bodies greater than 1mm (wire) protected against sprays of water up to 60 degrees from the vertical (rain)
	protected against ingress of solid bodies greater than 1mm (wire) protected against water splashed from all directions
	protected against limited ingress of dust (wet rooms/covered outdoor areas) protected against water splashed from all directions
	protected against ingress of dust protected against jets of water
	protected against ingress of dust protected against powerful jets of water or heavy seas
	protected against ingress of dust protected against immersion of water between 15cm - 1m for 30 minutes
	protected against ingress of dust protected against immersion of water under pressure for long periods

### IK RATING

	protected against 0.14 joules impact (equivalent to 0.25kg mass dropped from 56mm above the surface)
	protected against 0.2 joules impact (equivalent to 0.25kg mass dropped from 80mm above the surface)
	protected against 0.35 joules impact (equivalent to 0.25kg mass dropped from 140mm above the surface)
	protected against 0.5 joules impact (equivalent to 0.25kg mass dropped from 200mm above the surface)
	protected against 0.7 joules impact (equivalent to 0.25kg mass dropped from 280mm above the surface)
	protected against 1 joules impact (equivalent to 0.25kg mass dropped from 400mm above the surface)
	protected against 2 joules impact (equivalent to 0.5kg mass dropped from 400mm above the surface)
	protected against 5 joules impact (equivalent to 1.7kg mass dropped from 300mm above the surface)
	protected against 10 joules impact (equivalent to 5.0kg mass dropped from 200mm above the surface)
	protected against 20 joules impact (equivalent to 5.0kg mass dropped from 400mm above the surface)